



AX3000 Dual Band Gigabit Wi-Fi 6 Router

Next-Gen Wi-Fi for More Devices



Archer AX50

 Next-Gen Gigabit Wi-Fi
Speed up to 3 Gbps

 Connect More Devices
OFDMA + MU-MIMO

 Intel® Home Wi-Fi Chipset
Wi-Fi 6 Gig+ performance

 Maximized Coverage
Beamforming

Highlights

802.11 AX Wi-Fi 6 Gig+ Supports More Devices

The Archer AX50, with Wi-Fi 6 – based on the next generation 802.11ax Wi-Fi technology, takes your Wi-Fi to the next level while being backwards compatible with 802.11 a/b/g/n/ac Wi-Fi standards.

3X[≡]

3× Faster Speed^a

Powerful and consistent signals to perfectly pair with newer PCs and mobile devices equipped with 160 MHz Wi-Fi



75% Lower Latency

Take advantage of ultra-low latency to enjoy more responsive gaming and seamless video conferencing

4X[≡]

4× Increased Capacity

OFDMA greatly improves network efficiency and capacity to connect more devices simultaneously



Save Clients' Battery Power

Target Wake Time schedules the connection time of battery-powered devices to reduce their power consumption

Homecare™ - Taking Care of Your Wi-Fi Security

TP-Link HomeCare™, powered by Trend Micro™, protects every device from the latest cyber threats with powerful security, built-in antivirus, and cutting-edge intrusion prevention, comprehensively creating a highly protected smart home environment.

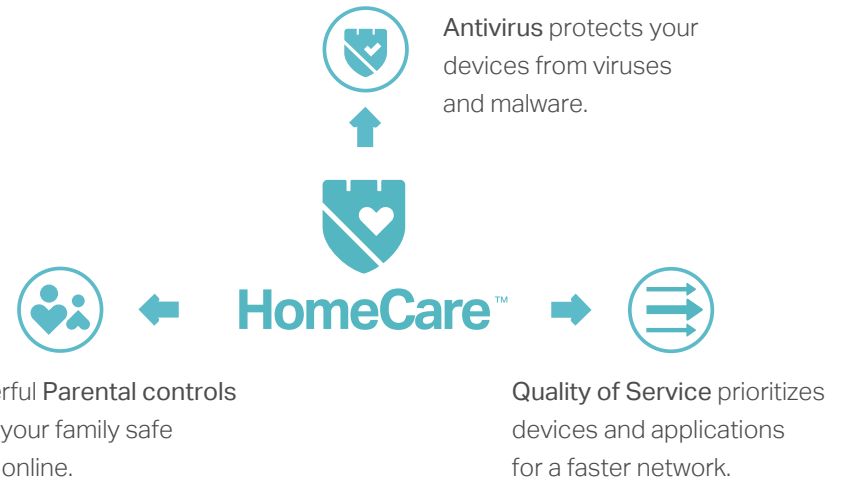

Highlights

Powerful CPU

A high-performance dual-core CPU delivers consistent and powerful signal strength to multiple devices at the same time. It also helps accelerate wired and wireless transmission simultaneously to keep your connections fast and uninterrupted.

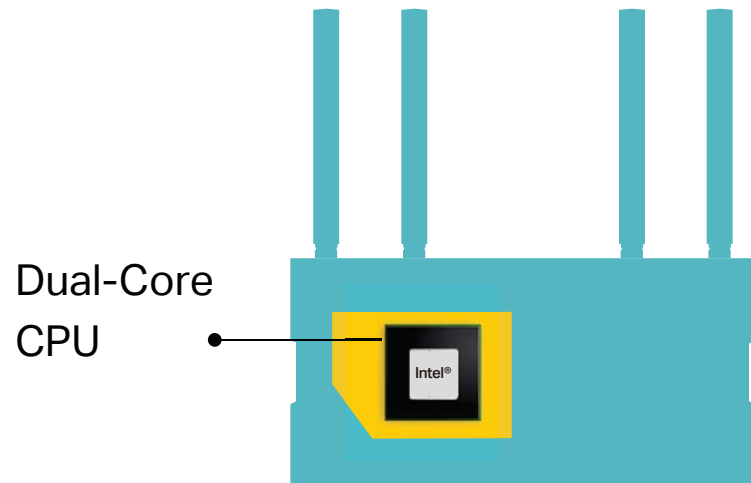

Boosted Coverage

Four high-gain external antennas and Beamforming transmit Wi-Fi signals to every corner of your home and concentrate signals strength towards connected devices. Wi-Fi 6 adjusts the bandwidth of sub-channels, making signals clearer and ensuring larger coverage.



Features



Speed

- **AX Tech** – 802.11ax (also known as Wi-Fi 6) features advanced technologies including OFDMA, MU-MIMO and 1024QAM, drastically increasing the speed and efficiency of the entire network
- **Ultimate Wireless Speed** – 574 Mbps on 2.4 GHz (802.11ax) + 2402 Mbps on 5 GHz (802.11ax)
- **Dual-Core CPU** – Helps accelerate wired and wireless transmission simultaneously to keep your connections fast and uninterrupted.
- **Link Aggregation** – Doubles the connection speeds to an external storage devices for faster streaming and data backup

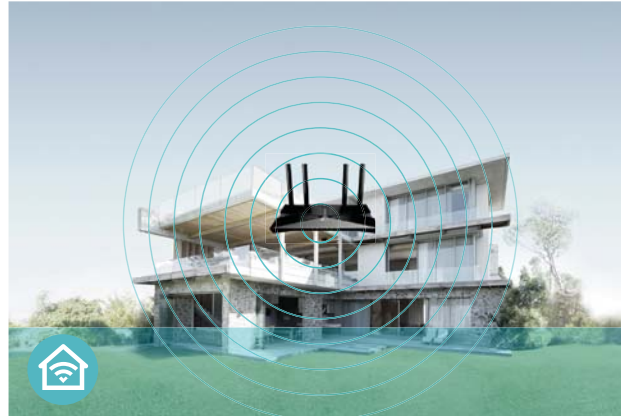

Wi-Fi Range

- **Ultimate Range Wi-Fi** – Four high-gain external antennas deliver a Wi-Fi signal to every corner of your home, making all of your connections more efficient and stable.
- **Beamforming Technology** – Concentrates Wi-Fi signals towards individual devices to ensure stronger connections



Reliability

- **Secure VPN Access** – Connects to a private network with a safe and secure OpenVPN and PPTP VPN connection
- **Airtime Fairness** – Balances bandwidth of connected devices to improve overall throughput and efficiency
- **Smart Connect** – Intelligently switches each device's connection to the optimum available Wi-Fi band
- **Easy Bandwidth Management** – Advanced QoS makes it easier for you to manage the bandwidth of connected devices or applications

Features



Ease of Use

- **Intuitive Web UI** – Ensures quick and simple Installation without hassle
- **Fast Encryption** – One-touch WPA wireless security encryption with the WPS button
- **Easy On/Off** – Turn on/off wireless radio using the Wi-Fi button; turn on/off LEDs using the LED button
- **Power On/Off** – Conveniently power on or off your router as required
- **Hassle-free Management with Tether App** – Network management is made easy with the TP-Link Tether App, available on any Android and iOS device



Security

- **Antivirus** – Protects all connected devices in your home from viruses and malware
- **Guest Network** – Keeps your main network secure by creating a separate network for friends and visitors
- **Access Control** – Establishes a whitelist or blacklist to allow or restrict certain devices to access the internet
- **Parental Controls** – Restricts internet access time and contents for children devices
- **Encryptions for Secure Network** – WPA-PSK and WPA2-PSK encryptions provide active protection against security threats

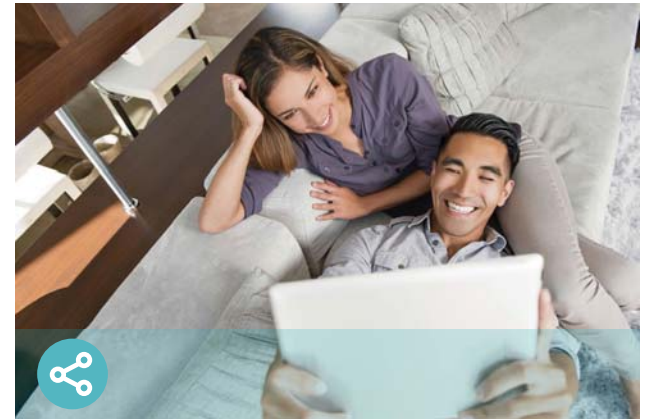

Easy Sharing

- **USB 3.0 Port** – Provide data transfers up to 10× faster than a traditional USB 2.0 port.
- **Built-in Media Server** – Allows you to play music, watch videos and view photos from any device on your network

Specifications

Hardware

- Ethernet Ports: One Gigabit WAN Port, four Gigabit LAN Ports
- USB Port: One Type A USB 3.0 Port
- Buttons: WPS/Wi-Fi Button, LED On/Off Button, Power On/Off Button, Reset Button
- Antennas: Four External Antennas
- External Power Supply: 12V/2A
- Dimensions (W x D x H): 10.2 × 5.3 × 1.5 in (260.2 x 135.0 x 38.6 mm)

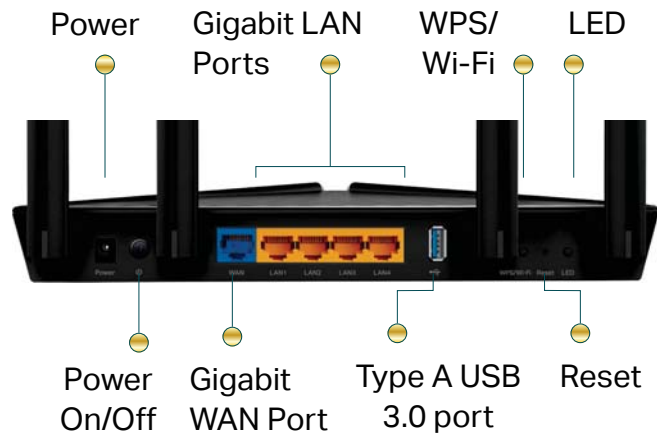

Wireless

- **Wireless:** 574 Mbps on 2.4 GHz (802.11ax) + 2402 Mbps on 5 GHz (802.11ax), compatible with 802.11a/b/g/n/ac Wi-Fi standards
- **Frequency:** 2.4 GHz and 5 GHz
- **Transmit Power:**
CE: <20dBm(2.4 GHz), <23dBm(5.15 GHz~5.35 GHz); <30dBm(5.47 GHz~5.725 GHz)
FCC:<30dBm(2.4 GHz & 5.15 GHz~5.825 GHz)
- **Reception Sensitivity:**
5 GHz:
11a 6Mbps:-97dBm, 11a 54Mbps:-79dBm
11ac VHT20_MCS0:-96dBm, 11ac VHT20_MCS11:-66dBm
11ac VHT40_MCS0:-94dBm, 11ac VHT40_MCS11:-63dBm
11ac VHT80_MCS0:-91dBm, 11ac VHT80_MCS11:-60dBm
11ac VHT160_MCS0:-88dBm, 11ac VHT160_MCS11:-55dBm
11ax HE20_MCS0:-95dBm, 11ax HE20_MCS11:-63dBm
11ax HE40_MCS0:-92dBm, 11ax HE40_MCS11:-60dBm
11ax HE80_MCS0:-89dBm, 11ax HE80_MCS11:-58dBm
11ax HE160_MCS0:-85dBm, 11ax HE160_MCS11:-55dBm
2.4 GHz:
11g 6Mbps:-97dBm, 11a 54Mbps:-79dBm
11n HT20_MCS0:-97dBm, 11n HT20_MCS7:-78dBm
11n HT40_MCS0:-95dBm, 11n HT40_MCS7:-75dBm
11ac VHT20_MCS0:-96dBm, 11ac VHT20_MCS11:-67dBm
11ac VHT40_MCS0:-94dBm, 11ac VHT40_MCS11:-64dBm
11ax HE20_MCS0:-96dBm, 11ax HE20_MCS11:-64dBm
11ax HE40_MCS0:-93dBm, 11ax HE40_MCS11:-61dBm
- **Wireless Function:** Enable/Disable Wireless Radio, WMM, Wireless Statistics
- **Wireless Security:** 64/128-bit WEP, WPA/WPA2, WPA-PSK/WPA2-PSK encryptions

Specifications

Software

- **Quality of Service:** Device and Application Prioritisation
- **WAN Type:** Dynamic IP/Static IP/PPPoE/PPTP(Dual Access)/L2TP(Dual Access)
- **Management:** Access Control, Local Management, Remote Management
- **DHCP:** Server, DHCP Client List, Address Reservation
- **Port Forwarding:** Virtual Server, Port Triggering, UPnP, DMZ
- **Dynamic DNS:** DynDns, NO-IP, TP-Link
- **Access Control:** Parental Controls, Local Management Control, Host List, White List, Black List
- **Firewall Security:** DoS, SPI Firewall, IP and MAC Address Binding
- **Protocols:** IPv4, IPv6
- **USB Sharing:** Supports Samba(Storage)/FTP Server/Media Server
- **Guest Network:** 2.4 GHz Guest Network, 5 GHz Guest Network

Others

- **Certification:**
CE, FCC, RoHS
- **System Requirements:**
Microsoft Windows 98SE/NT/2000/XP/Vista™/7/8/8.1/10, MAC OS, NetWare, UNIX or Linux
Internet Explorer 11, Firefox 12.0, Chrome 20.0, Safari 4.0, or other Java-enabled browser
Cable or DSL Modem
Subscription with an internet service provider (for internet access)
- **Environment:**
Operating Temperature: 0°C~40°C (32°F ~104°F)
Storage Temperature: -40°C~70°C (-40°F ~158°F)
Operating Humidity: 10%~90% non-condensing
Storage Humidity: 5%~90% non-condensing
- **Package Contents**
Wireless Router Archer AX50
Power Adapter
RJ45 Ethernet Cable
Quick Installation Guide



For more information, please visit

<http://www.tp-link.com/products/details/Archer-AX50.html>

or scan the QR code left

Attention: This device may only be used indoors in all EU member states and EFTA countries.

Specifications are subject to change without notice. TP-Link is a registered trademark of TP-Link Technologies Co., Ltd. Other brands and product names are trademarks or registered trademarks of their respective holders. Copyright ©2019 TP-Link Technologies Co., Ltd. All rights reserved.

*802.11ax 2x2 160 MHz enables 2402 Mbps maximum theoretical data rates, 3X faster than standard 802.11ac 2x2 80 MHz (867 Mbps) and nearly 6x faster than baseline 1x1ac (433 Mbps) Wi-Fi as documented in IEEE 802.11 wireless standard specifications, and require the use of similarly configured 802.11ax wireless network routers.

*Maximum wireless signal rates are the physical rates derived from IEEE Standard 802.11 specifications. Actual wireless data throughput and wireless coverage are not guaranteed and will vary as a result of network conditions, client limitations, and environmental factors, including building materials, obstacles, volume and density of traffic, and client location.

*Use of MU-MIMO and 1024-QAM requires clients to also support those functions.

*A basic TP-Link HomeCare™, powered by Trend Micro™, package is included for 3 years from date of activation at no additional cost. It includes Parental controls, Quality of Service, and Antivirus. Deactivation of HomeCare™ will disable certain controls and protections. For a complete list of HomeCare™ functions, go to www.tp-link.com.